

Varenummer: 203250M1280A1S  
 Beskrivelse: E+G Justerfod  
 GN 32-50-M12-80-A1-S  
 Note: S Uden møtrik, udvendig sekskant i bunden

## Mål

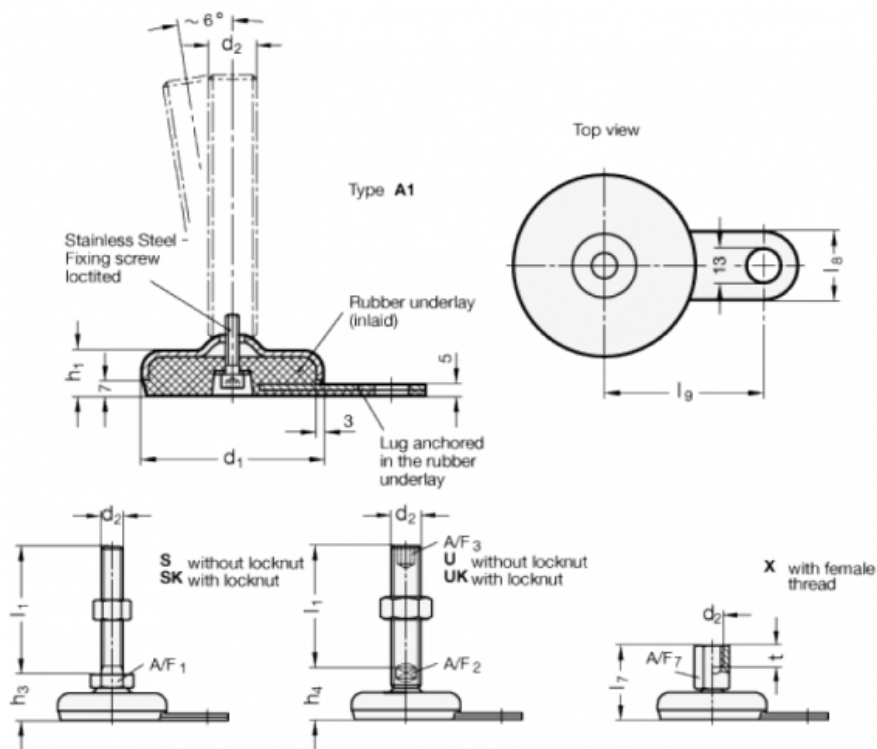

A/F1	= 17
d1	= 50
d2	= M12
h1	= 18
h3	= 26
l1	= 80
l8	= 25
l9	= 45